

ASSEMBLY INSTRUCTION
NUNEZ
ROUND COFFEE TABLE
ITEM CODE 85782

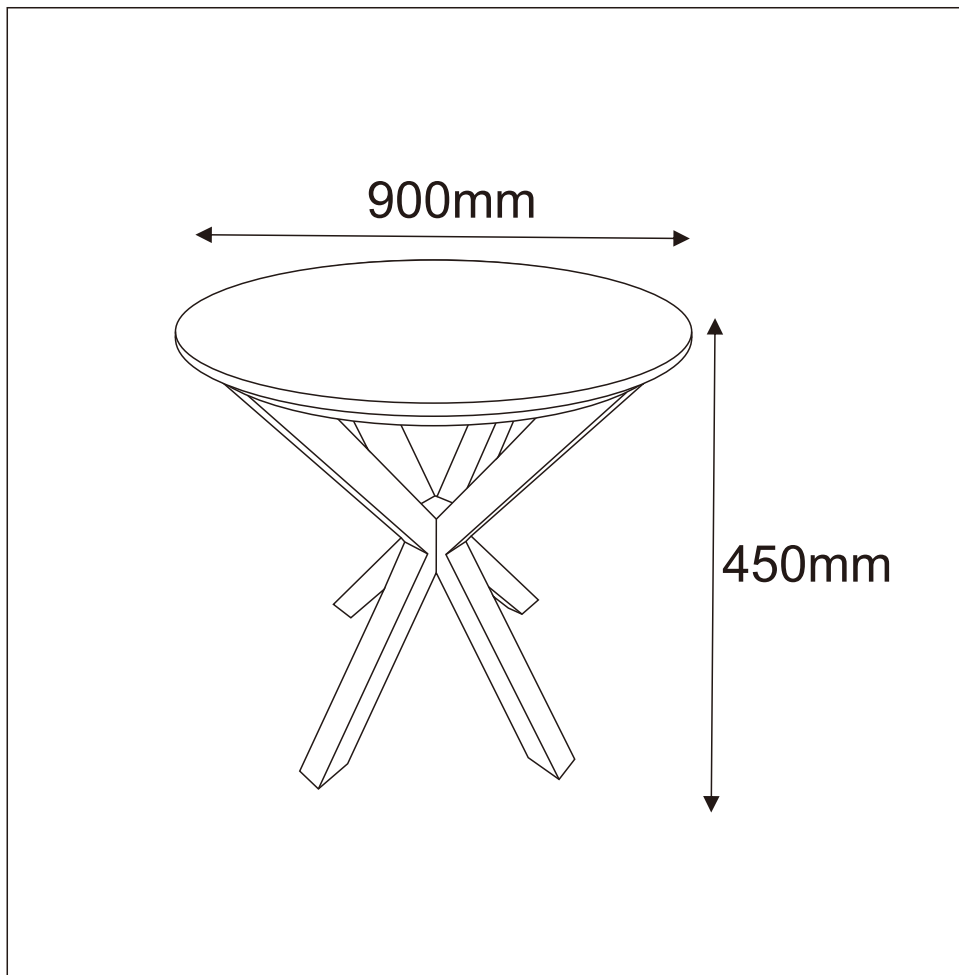



Imported by JWA Furniture Pty Ltd, Qld, Brisbane Australia.

For any assistance with assembly or for missing parts please refer to your receipt



PRE-ASSEMBLY PREPARATION

Before you start:

1. Choose a clean, level, spacious assembly area. Avoid hard surfaces that may damage the product
2. Take care when lifting. Product should be assembled as near as possible to the point of use
3. Ensure that you have all required contents for complete assembly
4. Always read the assembly instructions carefully before beginning assembly.
5. Keep all hardware parts and packaging out of reach of small children.
6. Do not over tighten the screws and bolts as this may damage the threads

		
Allow 10 min	For 2 people	Additional tools required

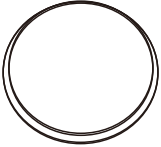
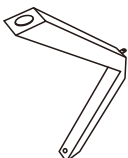
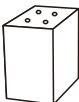
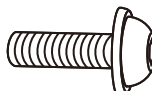
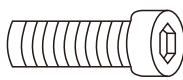
PARTS LIST

A	B	C	D	E
			 6x16mm	 8x20mm
1	4	1	4	4
F	G			
 M4	 M6			
1	1			

STEP 1:

- Put the table top (A) on a protected surface
- Tighten the table leg (B) to the table top with screw (E) 80% and Allen (G)
- Tighten the connect part (C) to the leg with screw (D) 80% and Allen (F)

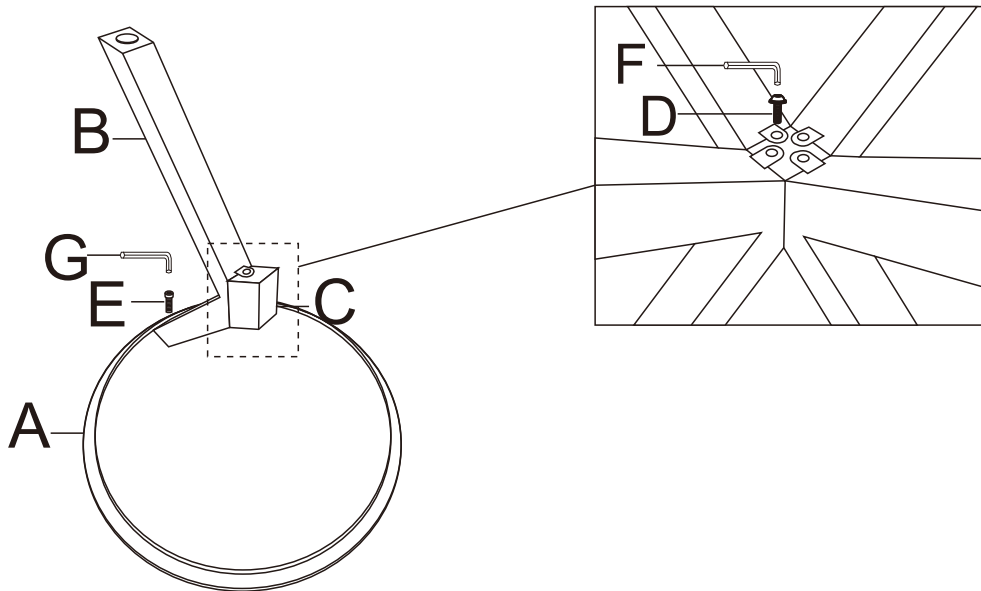

STEP 2:

- Repeat the STEP 1 and tighten all legs and connect part 80%
- Tighten all screws 100%

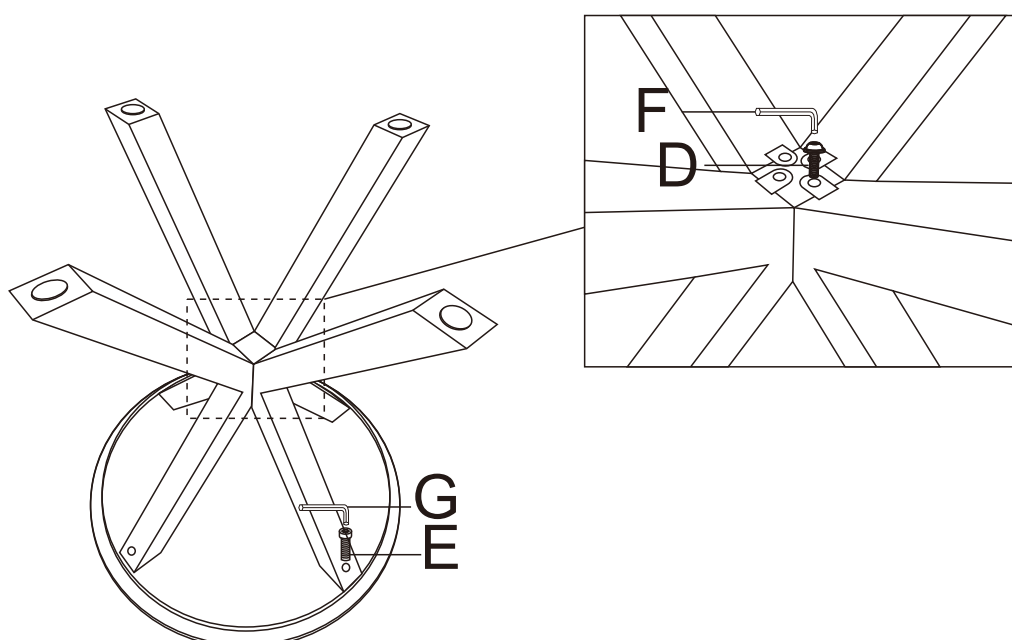

ASSEMBLY IS COMPLETE

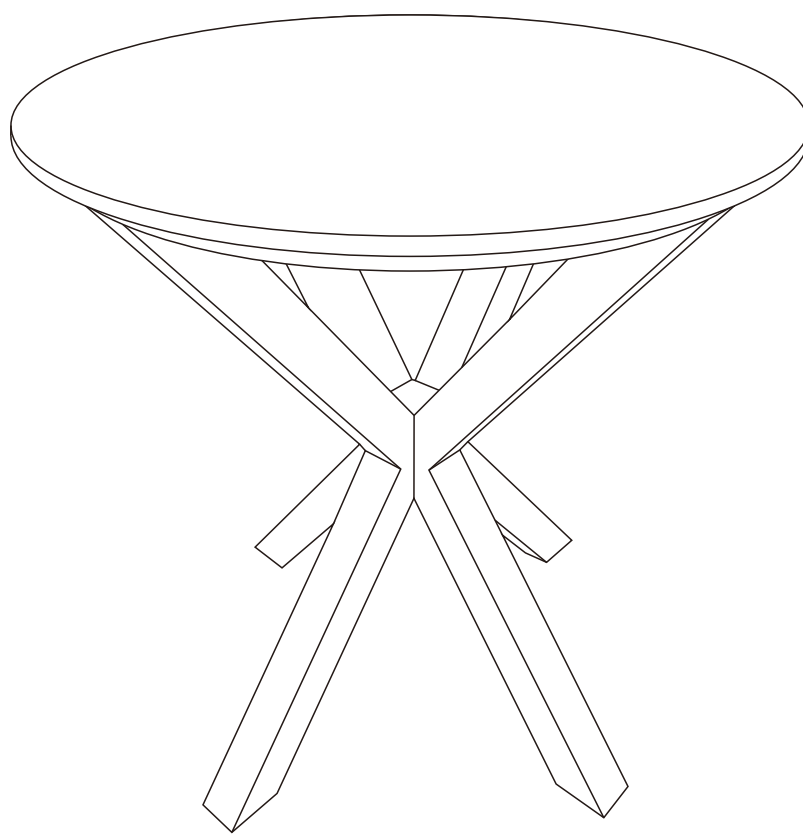

CARE AND MAINTENANCE

Daily Cleaning

- **General Stain Removal:** As the surface of sintered stone furniture is non - porous and non - absorbent, for daily cleaning, simply wiping with a soft, damp cloth can remove dust and light stains such as coffee stains and fruit juice stains. For more stubborn stains, a mild detergent can be used. However, avoid using cleaners that contain strong acids, strong alkalis, or abrasive components to prevent damage to the furniture surface.
- **Preventing Water Stain Residue:** After cleaning, wipe off the water in a timely manner to prevent water stain residue. Because long - term water stains may form water marks on the surface and affect the appearance.

Avoid Scratching and Collision

- **Careful Use:** In daily use, avoid using sharp objects such as knives and keys to scratch on the furniture surface, as this may cause scratches. Although sintered stone is relatively wear - resistant, sharp objects can still damage its surface.
- **Pay Attention to Moving:** When moving furniture, handle it with care and avoid collision with other hard objects. If you need to move heavy sintered stone furniture, it's best to ask professionals for help to prevent accidental collisions during the moving process and damage to the furniture.

Prevent Chemical Corrosion

- **Avoid Contact with Acid - Base Substances:** Sintered stone furniture should avoid contact with acidic or alkaline chemicals such as vinegar, lemon juice, and bleach. These substances may react chemically with the stone, causing the surface to discolor, corrode, or be damaged.
- **Choose Cleaners Carefully:** When choosing a cleaner, carefully check the product ingredients to ensure that it will not damage the sintered stone. If you're not sure whether a cleaner is suitable, you can first conduct a small - area test on an inconspicuous part of the furniture and observe whether there is any adverse reaction before using it.